

TECHNICAL SHEET

2Z20-72.36Y

Two-Stage Series - UL

LEGAL DISCLAIMER:

While Frascold has made every effort at the time of publication to ensure the accuracy of the information provided herein, product specifications and performances could be subject to change without notice.



Technical data - 2Z20-72.36Y



Number of pistons		4-2
Nominal motor power	HP	20
Nominal motor power	kW	14,9
Displacement LP @ (1450 rpm - 50 Hz)	m ³ /h	70,7
Displacement HP @ (1450 rpm - 50 Hz)	m ³ /h	35,4
Displacement LP @ (1740 rpm - 60 Hz)	m ³ /h	84,9
Displacement HP @ (1740 rpm - 60 Hz)	m ³ /h	42,4
Power supply	V/ph/Hz/Connection	400/3/50/PWS
MRA	A	37
LRA	A	106,6
LRA DOL	A	180,5
Net weight	kg	225
Lubricant		FRASCOLD POE32
Oil charge	l	7,2
Maximum operating pressure HP	bar	30
Maximum static pressure LP	bar	20,5
Capacity step	%	100

Standard accessories - 2Z20-72.36Y



Suction and discharge valves with soldering connection

IP65 terminal box

Oil level sight glass(es)

Rubber vibration dampers (4 pcs)

Nitrogen protective charge

Packing ensuring proper handling and protection

PTC discharge temperature sensor

T00EC50-RIC

Electronic oil pressure switch

T00EC1630DRIC

Injection control module and solenoid valve

Optional accessories - 2Z20-72.36Y

Electronic protection and diagnostic module INT69 Diagnose

T00EC01D-RIC

Electronic protection and diagnostic module INT69TML Diagnose

T00ECA11D

Special voltage for electrical motor

Crankcase heater

Liquid subcooler

USB adapter for Diagnose

T00EC57

Bluetooth Module for Diagnose

T00EC69

Modbus connection cable

T00EC65

DP-Modbus gateway

T00EC59

Special painting

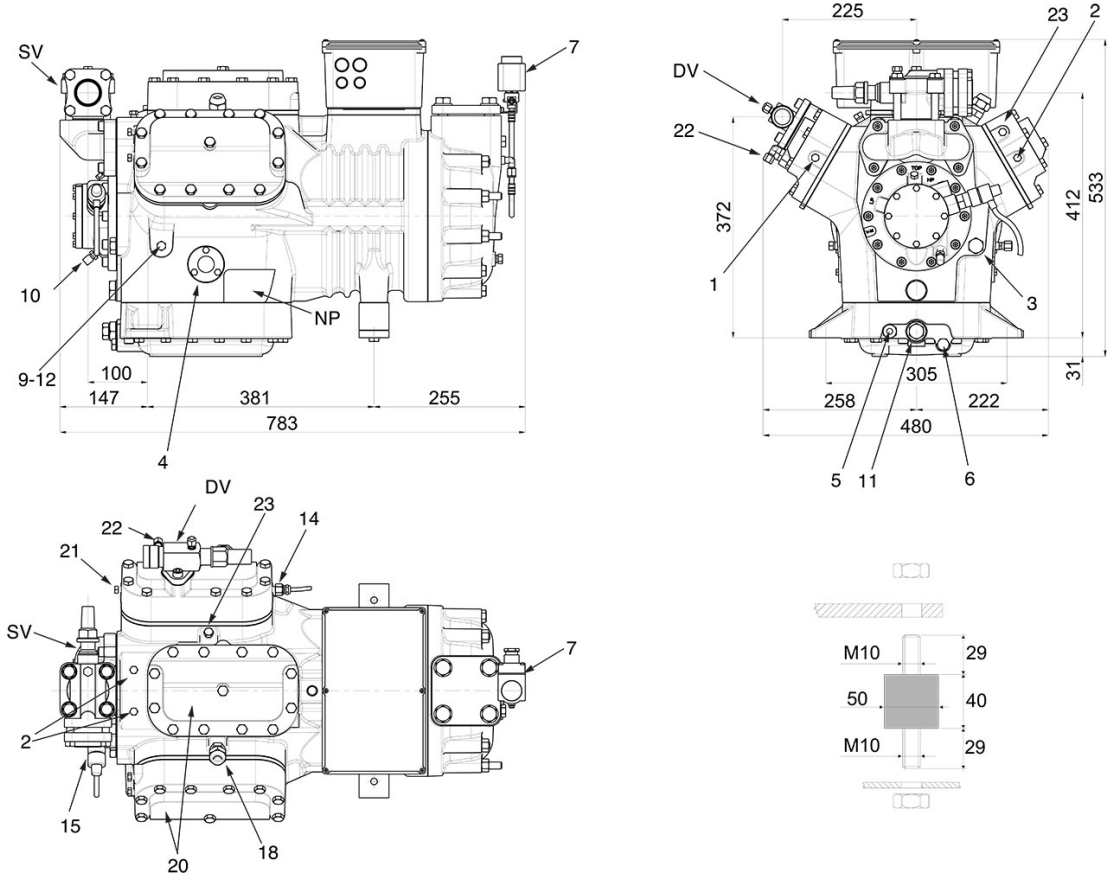

Position and connections:

SV: Suction Valve	mm	42
SV: Suction Valve	inch	1 5/8"
DV: Discharge valve	mm	35
DV: Discharge valve	inch	1 3/8"
1: High pressure connection		1/8" NPT
2: Low pressure connection		1/8" NPT
3: Oil charge plug		3/8" GAS
4: Oil level sight glass		-
5: Crankcase heater seat		-
6: Oil drain plug		1/4" GAS
7: Liquid injection plug		1/8" SAE
9: Oil pressure switch connection (LP)		1/4" NPT
10: Oil pressure switch connection (HP)		1/4" SAE
11: Oil filter		3/8" GAS
12: Oil return plug		1/4" NPT
13: Magnetic plug		-
14: Max discharge temperature sensor connection		1/8" NPT
15: Electronic oil pressure switch connection		-
18: ECO/liquid injection connection		5/8" SAE
19: 1°-2° stage collector		-
20: 1° stage head		-
21: 2° stage head		-
22: Thermostatic valve equalization line plug		1/4" SAE
23: Mean pressure connection		1/8" NPT
24: External equalizer liquid injection connection		-
NP: Nameplate		-