

TECHNICAL SHEET

CXH92-180-545Y

CX Air SERIES

LEGAL DISCLAIMER:

While Frascold has made every effort at the time of publication to ensure the accuracy of the information provided herein, product specifications and performances could be subject to change without notice.



Technical data - CXH92-180-545Y



Nominal motor power	HP	180
Nominal motor power	kW	134,2
Displacement @ (2900 rpm - 50 Hz)	m ³ /h	545
Displacement @ (3480 rpm - 60 Hz)	m ³ /h	654
Power supply	V/ph/Hz/Connection	400/3/50/SDS
MRA	A	332
LRA	A	465
LRA DOL	A	1442
Maximum frequency	Hz	70
Minimum frequency	Hz	30
Net weight	kg	1380
Lubricant		FRASCOLD POE170
Oil charge	l	26
Maximum operating pressure HP	bar	30
Maximum static pressure LP	bar	20,5
Capacity step	%	100-75-50-25

Standard accessories - CXH92-180-545Y



Electronic protection module INT69FRY	T00EC45B
Integrated 3-stage internal oil separator	
Replaceable oil filter	
Crankcase heater	T00CH37
Oil level sight glass(es)	
Suction flange with solder sleeve	
Discharge valve with soldering connection	
Integrated check valve and internal pressure relief valve	
Step capacity control and unloaded start	
IP65 terminal box	
Oil temperature PTC sensor	T00EC53
Oil drain valve	
Nitrogen protective charge	
Packing ensuring proper handling and protection	

Optional accessories - CXH92-180-545Y

Electronic protection and diagnose module INT69FRYL	T00EC45AD
Suction valve with soldering connection	
Axial suction layout	
Stepless capacity control	
Special voltage for electric motor	
Opto electronic oil level control	T00WP253
Oil Flow Switch	T00WK1400
Oil Filter Clogging Differential Pressure Switch (Electronic)	T00WK151
Electronic Alarm Control Module	T00EC28
Connection Kit for Economiser or Liquid Injection	
Adapter Kit for External Oil cooler	T00WK1450
Bridges for DOL Start	
Rubber vibration dampers (4 pcs)	
Special painting	
Special version for external VFD (CXHI)	
Special version for parallel installation (CXHP)	

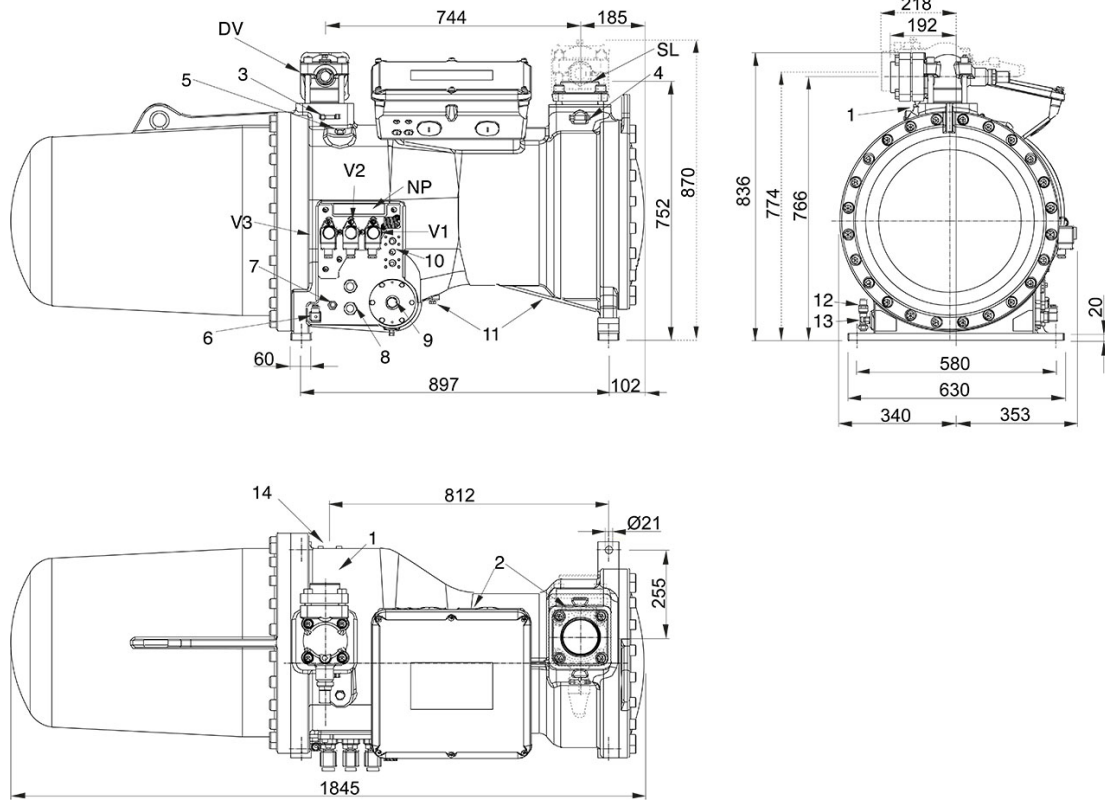

Position and connections:

SV: Suction Valve	mm	105
SV: Suction Valve	inch	4 1/8"
DV: Discharge valve	mm	80
DV: Discharge valve	inch	DN80
SL: Suction line		4 1/8"
V1: Capacity control valve		-
V2: Capacity control valve		-
V3: Capacity control valve		-
1: High pressure connection		1/8" NPT
2: Low pressure connection		1/8" NPT
3: High pressure connection		1/4" SAE x 1/4" SAE
4: Low pressure connection		1/4" SAE x 1/4" SAE
5: Oil charge plug		3/8" GAS
6: Crankcase heater		-
7: Oil level regulator connection		3/4" NPT
8: Oil level sight glass		-
9: Filter clogging sensor connection		1/2" GAS
10: Oil cooler connection		1/2" NPT
11: Oil drain plug		1/4" NPT
12: Oil drain valve		1/8" NPT
13: Maximum oil temperature sensor		-
14: ECO/liquid injection connection		1 3/8"
NP: Nameplate		-