

TECHNICAL SHEET

V15-71Y

Standard Reciprocating SERIES

LEGAL DISCLAIMER:

While Frascold has made every effort at the time of publication to ensure the accuracy of the information provided herein, product specifications and performances could be subject to change without notice.



Technical data - V15-71Y



Number of pistons		4
Nominal motor power	HP	15
Nominal motor power	kW	11,2
Displacement @ (1450 rpm - 50 Hz)	m ³ /h	70,8
Displacement @ (1740 rpm - 60 Hz)	m ³ /h	84,9
Power supply	V/ph/Hz/Connection	400/3/50/PWS
MRA	A	32,2
LRA	A	74,8
LRA DOL	A	117,1
Power supply	V/ph/Hz/Connection	230/3/50/DOL-DELTA
MRA	A	53,7
LRA	A	204
LRA DOL	A	null
Maximum frequency	Hz	70
Minimum frequency	Hz	30
Net weight	kg	170
Lubricant		FRASCOLD POE68
Oil charge	l	4
Maximum operating pressure HP	bar	30
Maximum static pressure LP	bar	20,5
Capacity step	%	100-75-50

Standard accessories - V15-71Y

Suction and discharge valves with soldering connection

Packing ensuring proper handling and protection

PTC discharge temperature sensor

T00EC50-RIC

Electronic oil pressure switch

T00EC1630DRIC

IP65 terminal box

Oil level sight glass(es)

Electronic protection and diagnostic module INT69TML Diagnose

T00ECA11D

Rubber vibration dampers (4 pcs)

Nitrogen protective charge

Optional accessories - V15-71Y

Special voltage for electrical motor

Crankcase heater

CC capacity control head

RSH capacity control head

US unloaded start head

Electronic oil level switch

T00WK252

Head Cooling Fan

FLI liquid injection kit

Oil Equalizing Fitting with valve

USB adapter for Diagnose

T00EC57

Bluetooth Module for Diagnose

T00EC69

Modbus connection cable

T00EC65

DP-Modbus gateway

T00EC59

Special painting

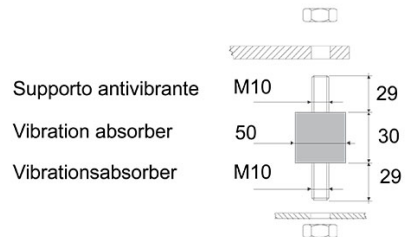
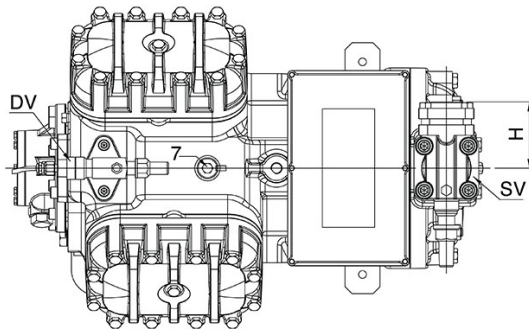
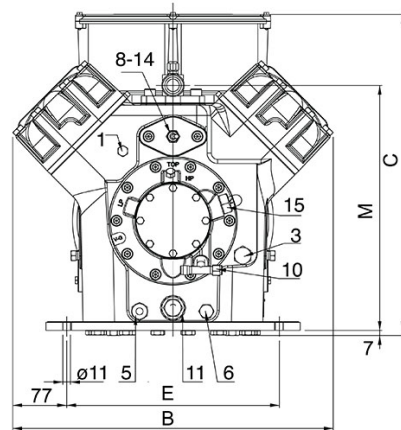
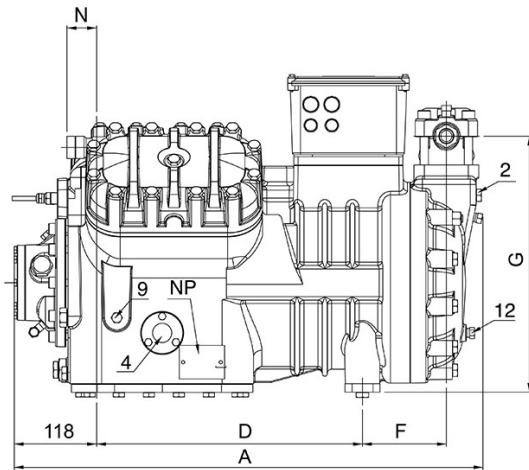

Position and connections:



SV: Suction Valve	mm	42
SV: Suction Valve	inch	1 5/8"
DV: Discharge valve	mm	28,6
DV: Discharge valve	inch	1 1/8"
A: Length	mm	672
B: Width	mm	460
C: Height	mm	463
D: Base mounting	mm	381
E: Base mounting	mm	305
F: Suction Valve	mm	120
G: Suction Valve	mm	367
H: Suction Valve	mm	95
L: Discharge valve	mm	152
M: Discharge valve	mm	352
N: Discharge valve	mm	43
1: High pressure connection		1/8" NPT
2: Low pressure connection		1/4" NPT
3: Oil charge plug		3/8" GAS
4: Oil level sight glass		-
5: Crankcase heater seat		-
6: Oil drain plug		1/4" GAS
7: Liquid injection plug		1/4" NPT
8: Liquid injection sensor plug		1/8" NPT
9: Oil pressure switch connection (LP)		1/4" NPT
10: Oil pressure switch connection (HP)		1/4" SAE
11: Oil filter		3/8" GAS
12: Oil return plug		1/4" NPT
14: Max discharge temperature sensor connection		1/8" NPT
15: Electronic oil pressure switch connection		3/4 UNF
NP: Nameplate		-