

TECHNICAL SHEET

Z40-154Y

Standard Reciprocating SERIES

LEGAL DISCLAIMER:

While Frascold has made every effort at the time of publication to ensure the accuracy of the information provided herein, product specifications and performances could be subject to change without notice.



Technical data - Z40-154Y



Number of pistons		6
Nominal motor power	HP	40
Nominal motor power	kW	29,8
Displacement @ (1450 rpm - 50 Hz)	m ³ /h	154,4
Displacement @ (1740 rpm - 60 Hz)	m ³ /h	185,3
Power supply	V/ph/Hz/Connection	400/3/50/PWS
MRA	A	77,9
LRA	A	159,2
LRA DOL	A	273
Power supply	V/ph/Hz/Connection	230/3/50/DOL-DELTA
MRA	A	129
LRA	A	374
LRA DOL	A	null
Maximum frequency	Hz	70
Minimum frequency	Hz	30
Net weight	kg	240
Lubricant		FRASCOLD POE68
Oil charge	l	7,2
Maximum operating pressure HP	bar	30
Maximum static pressure LP	bar	20,5
Capacity step	%	100-83-67-50

Standard accessories - Z40-154Y



Suction and discharge valves with soldering connection

Packing ensuring proper handling and protection

PTC discharge temperature sensor

T00EC50-RIC

Electronic oil pressure switch

T00EC1630DRIC

IP65 terminal box

Oil level sight glass(es)

Electronic protection and diagnostic module INT69TML Diagnose

T00ECA11D

Rubber vibration dampers (4 pcs)

Nitrogen protective charge

Optional accessories - Z40-154Y

Special voltage for electrical motor

Crankcase heater

CC capacity control head

RSH capacity control head

US unloaded start head

Electronic oil level switch

T00WK252

Head Cooling Fan

FLI liquid injection kit

Oil Equalizing Fitting with valve

USB adapter for Diagnose

T00EC57

Bluetooth Module for Diagnose

T00EC69

Modbus connection cable

T00EC65

DP-Modbus gateway

T00EC59

Special painting

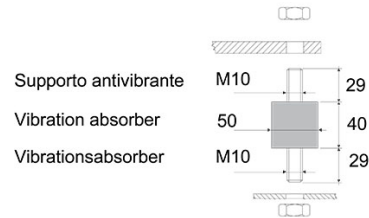
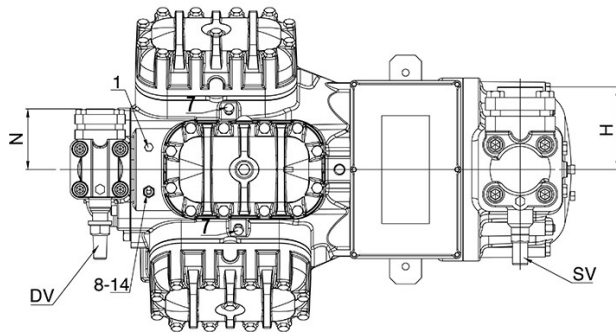
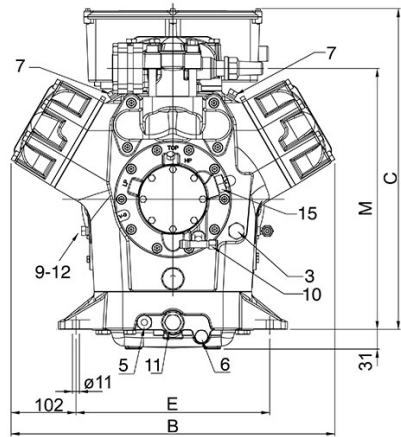
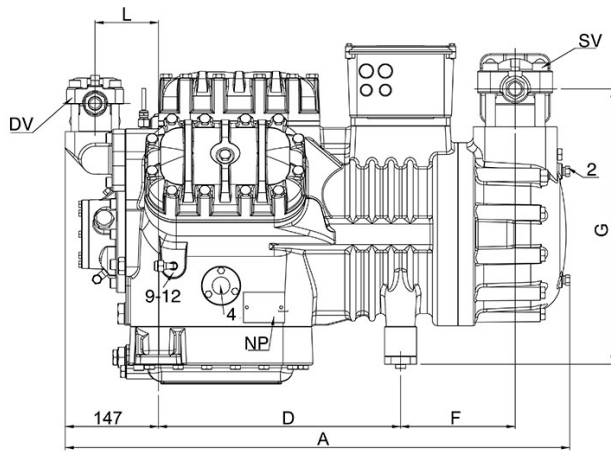

Position and connections:



SV: Suction Valve	mm	67
SV: Suction Valve	inch	2 5/8"
DV: Discharge valve	mm	42
DV: Discharge valve	inch	1 5/8"
A: Length	mm	794
B: Width	mm	509
C: Height	mm	536
D: Base mounting	mm	381
E: Base mounting	mm	305
F: Suction Valve	mm	180
G: Suction Valve	mm	433
H: Suction Valve	mm	130
L: Discharge valve	mm	100
M: Discharge valve	mm	411
N: Discharge valve	mm	95
1: High pressure connection		1/8" NPT
2: Low pressure connection		1/4" NPT
3: Oil charge plug		3/8" GAS
4: Oil level sight glass		-
5: Crankcase heater seat		-
6: Oil drain plug		1/4" GAS
7: Liquid injection plug		1/4" NPT
8: Liquid injection sensor plug		1/8" NPT
9: Oil pressure switch connection (LP)		1/4" NPT
10: Oil pressure switch connection (HP)		1/4" SAE
11: Oil filter		3/8" GAS
12: Oil return plug		1/4" NPT
14: Max discharge temperature sensor connection		1/8" NPT
15: Electronic oil pressure switch connection		-
NP: Nameplate		-